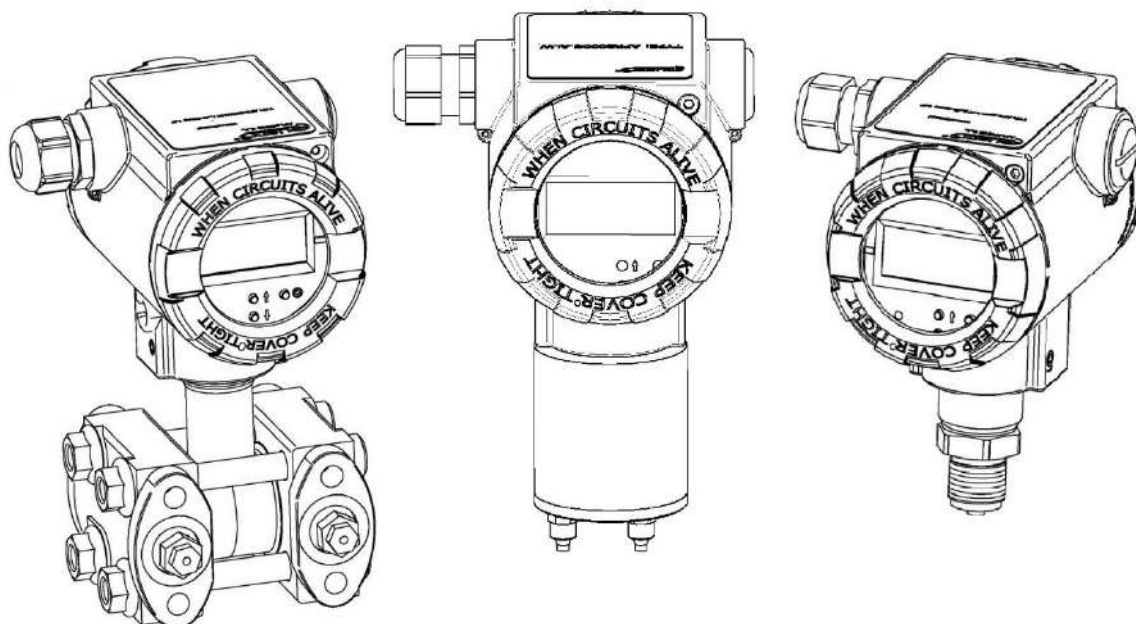




## USER'S MANUAL

PRESSURE AND DIFFERENTIAL PRESSURE TRANSMITTERS

**APC-2000ALW, APR-2000ALW, APR-2000ALW/G,  
APR-2000ALW with diaphragm seals**



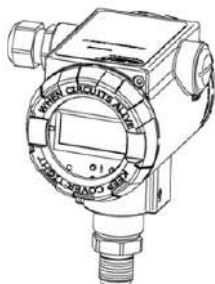
PRODUCT CODE – see: → [Transmitter identification](#).

The QR code or ID number identifies the transmitter and provides quick access to the following documentation on the manufacturer's website: user's manual, explosion-proof device user manual, technical information, declarations of conformity and copies of certificates.

### APC-2000ALW

ID:0005 0007 0005 0000 0000 0000 0001 05

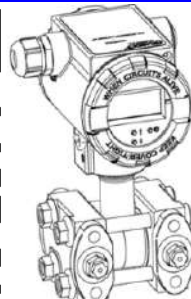
<https://www.aplisens.pl/ID/000500070005000000000000000000105>



### APR-2000ALW

ID:0006 0007 0005 0000 0000 0000 0001 02

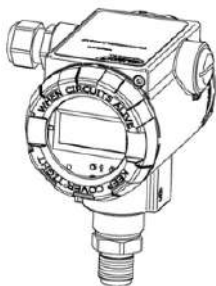
<https://www.aplisens.pl/ID/000600070005000000000000000000102>



### APC-2000ALW (Exi)

ID:0005 0007 0005 0000 0000 0015 0001 46

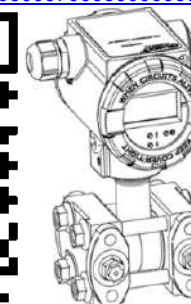
<https://www.aplisens.pl/ID/0005000700050000000000000015000146>



### APR-2000ALW (Exi)

ID:0006 0007 0005 0000 0000 0015 0001 43

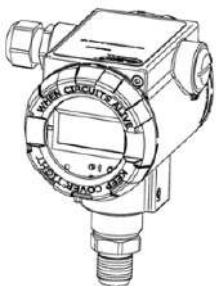
<https://www.aplisens.pl/ID/0006000700050000000000000015000143>



### APC-2000ALW (Exd)

ID:0005 0008 0006 0000 0000 0017 0001 86

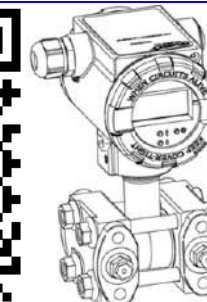
<https://www.aplisens.pl/ID/0005000800060000000000000017000186>



### APR-2000ALW (Exd)

ID:0006 0008 0006 0000 0000 0017 0001 83

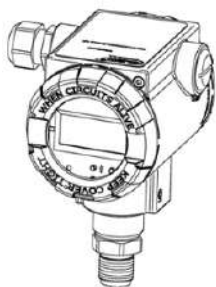
<https://www.aplisens.pl/ID/0006000800060000000000000017000183>



### APC-2000ALW (Exi/Exd)

ID:0005 0004 0006 0000 0000 0018 0001 64

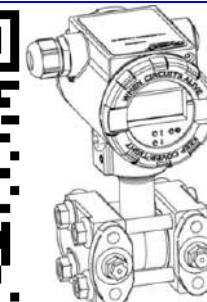
<https://www.aplisens.pl/ID/0005000400060000000000000018000164>



### APR-2000ALW (Exi/Exd)

ID:0006 0004 0006 0000 0000 0018 0001 61

<https://www.aplisens.pl/ID/0006000400060000000000000018000161>

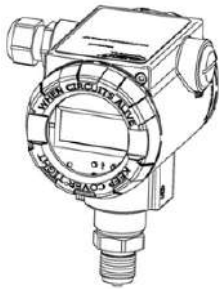


## APC-2000ALW

(For sea uses)

ID:0005 0007 0005 0000 0000 0003 0001 52

<https://www.aplisens.pl/ID/000500070005000000000003000152>

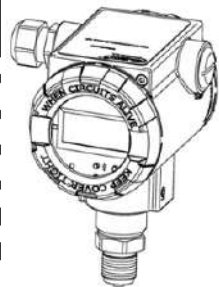


## APC-2000ALW (Exi)

(For sea uses)

ID:0005 0007 0005 0000 0000 0019 0001 44

<https://www.aplisens.pl/ID/0005000700050000000000019000144>

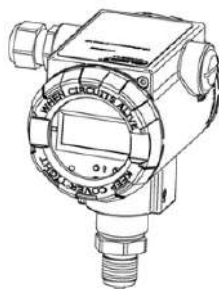


## APC-2000ALW (Exd)

(For sea uses)

ID:0005 0008 0006 0000 0000 0020 0001 36

<https://www.aplisens.pl/ID/0005000800060000000000020000136>

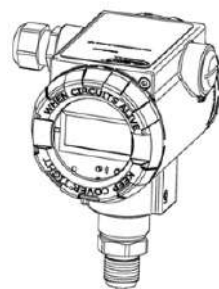


## APC-2000ALW (Exd)

(UKCA)

ID:0005 0008 0006 0000 0000 0022 0001 35

<https://www.aplisens.pl/ID/0005000800060000000000022000135>

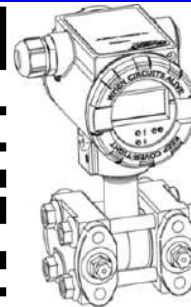


## APR-2000ALW

(For sea uses)

ID:0006 0007 0005 0000 0000 0003 0001 49

<https://www.aplisens.pl/ID/000600070005000000000003000149>

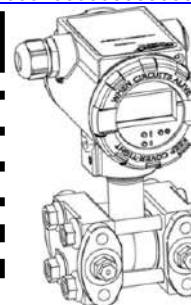
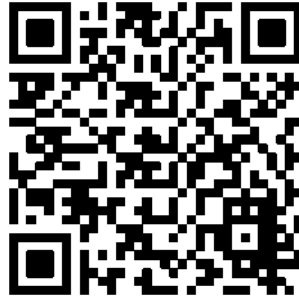


## APR-2000ALW (Exi)

(For sea uses)

ID:0006 0007 0005 0000 0000 0019 0001 41

<https://www.aplisens.pl/ID/0006000700050000000000019000141>

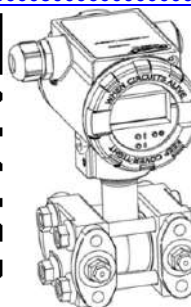


## APR-2000ALW (Exd)

(For sea uses)

ID:0006 0008 0006 0000 0000 0020 0001 33

<https://www.aplisens.pl/ID/0006000800060000000000020000133>



## APR-2000ALW (Exd)

(UKCA)

ID:0006 0008 0006 0000 0000 0022 0001 32

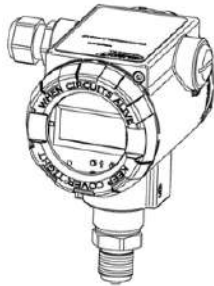
<https://www.aplisens.pl/ID/0006000800060000000000022000132>



## APC-2000ALW (Exi, Exi/Exd) (UKCA)

ID:0005 0004 0006 0000 0000 0022 0001 62

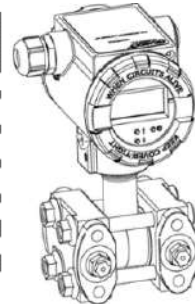
<https://www.aplisens.pl/ID/00050004000600000000000022000162>



## APR-2000ALW (Exi, Exi/Exd) (UKCA)

ID: 0006 0004 0006 0000 0000 0022 0001 59

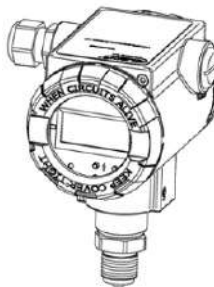
<https://www.aplisens.pl/ID/00060004000600000000000022000159>



## APC-2000ALW (IS)

ID:0005 0004 0006 0000 0000 0010 0001 68

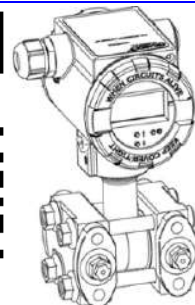
<https://www.aplisens.pl/ID/00050004000600000000000010000168>



## APR-2000ALW (IS)

ID:0006 0004 0006 0000 0000 0010 0001 65

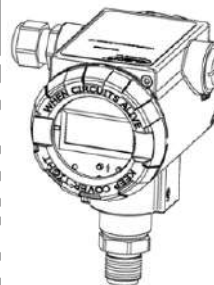
<https://www.aplisens.pl/ID/00060004000600000000000010000165>



## APC-2000ALW (XPC)

ID:0005 0008 0006 0000 0000 0011 0001 89

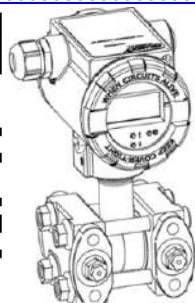
<https://www.aplisens.pl/ID/000500080006000000000000011000189>



## APR-2000ALW (XPC)

ID:0006 0008 0006 0000 0000 0011 0001 86

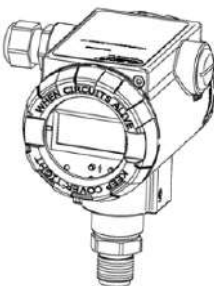
<https://www.aplisens.pl/ID/000600080006000000000000011000186>



## APC-2000ALW (IS/XPC)

ID:0005 0004 0006 0000 0000 0012 0001 67

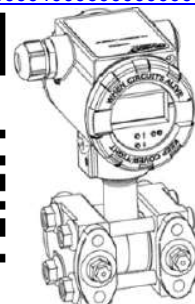
<https://www.aplisens.pl/ID/00050004000600000000000012000167>



## APR-2000ALW (IS/XPC)

ID:0006 0004 0006 0000 0000 0012 0001 64

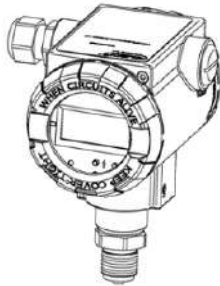
<https://www.aplisens.pl/ID/00060004000600000000000012000164>



### APC-2000ALW (XP)

ID:0005 0008 0006 0000 0000 0013 0001 88

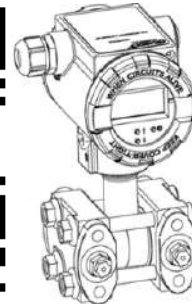
<https://www.aplisens.pl/ID/00050008000600000000000013000188>



### APR-2000ALW (XP)

ID:0006 0008 0006 0000 0000 0013 0001 85

<https://www.aplisens.pl/ID/00060008000600000000000013000185>



### APC-2000ALW (IS/XP)

ID:0005 0004 0006 0000 0000 0014 0001 66

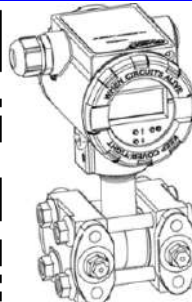
<https://www.aplisens.pl/ID/00050004000600000000000014000166>



### APR-2000ALW (IS/XP)

ID:0006 0004 0006 0000 0000 0014 0001 63

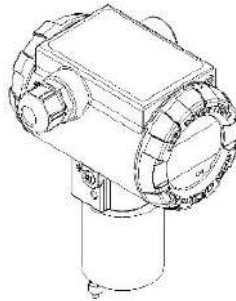
<https://www.aplisens.pl/ID/00060004000600000000000014000163>



### APR-2000ALW/G

ID:0008 0007 0005 0000 0000 0000 0001 93

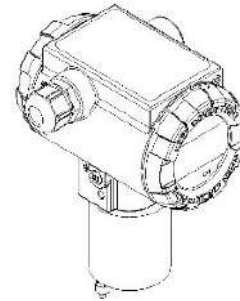
<https://www.aplisens.pl/ID/00080007000500000000000000000193>



### APR-2000ALW/G (Exi, Exi/Exd) (UKCA)

ID:0008 0004 0006 0000 0000 0022 0001 26

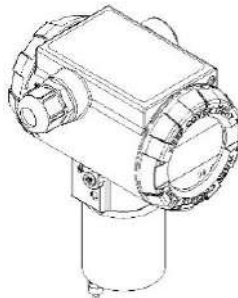
<https://www.aplisens.pl/ID/00080007000500000000000022000126>



### APR-2000ALW/G (Exd) (UKCA)

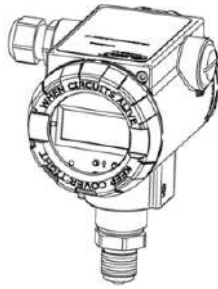
ID:0008 0008 0006 0000 0000 0022 0001 26

<https://www.aplisens.pl/ID/00080008000600000000000022000126>



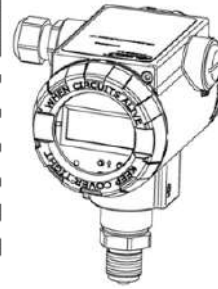
**APC-2000ALW (Exi, Exi/Exd)  
(Inmetro Brasil)**

ID: 0005 0004 0006 0000 0000 0021 0001 14  
<https://www.aplisens.pl/ID/00050004000600000000000021000114>



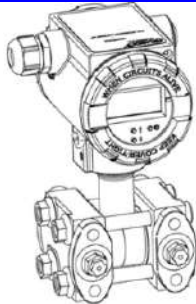
**APC-2000ALW (Exd)  
(Inmetro Brasil)**

ID: 0005 0008 0006 0000 0000 0021 0001 84  
<https://www.aplisens.pl/ID/00050008000600000000000021000184>



**APR-2000ALW (Exi, Exi/Exd)  
(Inmetro Brasil)**

ID: 0006 0004 0006 0000 0000 0021 0001 11  
<https://www.aplisens.pl/ID/00060004000600000000000021000111>



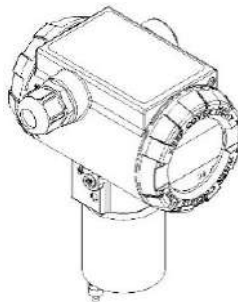
**APR-2000ALW (Exd)  
(Inmetro Brasil)**

ID: 0006 0008 0006 0000 0000 0021 0001 81  
<https://www.aplisens.pl/ID/00060008000600000000000021000181>



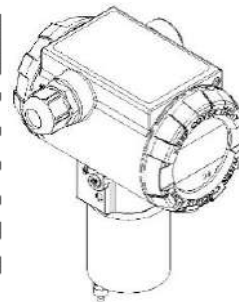
**APR-2000ALW/G (Exi, Exi/Exd)  
(Inmetro Brasil)**

ID: 0008 0004 0006 0000 0000 0021 0001 05  
<https://www.aplisens.pl/ID/00080004000600000000000021000105>







**APR-2000ALW/G (Exd)  
(Inmetro Brasil)**

ID: 0008 0008 0006 0000 0000 0021 0001 75  
<https://www.aplisens.pl/ID/00080008000600000000000021000175>



## Symbols used

Symbol	Description
	Warning to proceed strictly in accordance with the information contained in the documentation in order to ensure the safety and full functionality of the device.
	Information particularly useful during installation and operation of the device.
	Information particularly useful during installation and operation of an Ex type device.
	Information on disposal of used equipment.

### BASIC REQUIREMENTS AND SAFE USE



The manufacturer will not be liable for damage resulting from incorrect installation, failure to maintain a suitable technical condition of the device or use of the device other than for its intended purpose.

Installation should be carried out by qualified staff having the required authorizations to install electrical and I&C equipment. The installer is responsible for performing the installation in accordance with manual as well as with the electromagnetic compatibility and safety regulations and standards applicable to the type of installation.

In systems with I&C equipment, in case of leakage, there is a danger to staff due to the medium under pressure. All safety and protection requirements must be observed during installation, operation and inspections.

If a malfunction occurs, the device should be disconnected and handed over to the manufacturer for repair.



In order to minimize the risk of malfunction and associated risks to staff, the device is not to be installed or used in particularly unfavourable conditions, where the following hazards occur:

- possible mechanical impacts, excessive shocks and vibration;
- excessive temperature fluctuation;
- water vapour condensation, dusting, icing.

Changes made to the manufacturing of products may be introduced before the paper version of the manual is updated. The up-to-date manuals are available on the manufacturer's website: [www.aplisens.com](http://www.aplisens.com).

## TABLE OF CONTENTS

<b>1. INTRODUCTION</b> .....	<b>10</b>
1.1. Purpose of the document .....	10
1.2. Trademarks .....	10
1.3. Definitions and abbreviations .....	11
1.4. Transmitter set range .....	12
<b>2. SAFETY</b> .....	<b>13</b>
<b>3. TRANSPORT AND STORAGE</b> .....	<b>13</b>
3.1. Delivery check .....	13
3.2. Transport .....	13
3.3. Storage .....	13
<b>4. GUARANTEE</b> .....	<b>13</b>
<b>5. IDENTIFICATION</b> .....	<b>14</b>
5.1. Manufacturer's address .....	14
5.2. Transmitter identification .....	14
5.3. CE or UKCA mark and declaration of conformity .....	14
<b>6. INSTALLATION</b> .....	<b>15</b>
6.1. General recommendations .....	15
6.1.1. Examples of transmitter installation .....	15
6.1.2. Installation instructions for transmitters with distance separators .....	15
<b>7. ELECTRICAL CONNECTION</b> .....	<b>16</b>
7.1. Cable connection to transmitter internal terminals .....	16
7.1.1. Cable connection .....	16
7.1.2. Connection of transmitter with the option of using local HART communication .....	17
7.2. Transmitter power supply .....	19
7.2.1. Transmitter supply voltage .....	19
7.2.2. Uninterruptible current measurement in 4...20 mA current loop .....	20
7.2.3. Specifications of electrical switching terminals .....	20
7.2.4. Cabling specification .....	20
7.2.5. Resistance load in power supply line .....	20
7.2.6. Shielding, equipotential bonding .....	20
7.3. Equipotential bonding .....	20
7.4. Overvoltage protection .....	20
7.5. Final inspection of cabling .....	21
<b>8. START-UP</b> .....	<b>21</b>
8.1. Alarm configuration .....	21
8.2. Configuration of operating mode .....	23
8.3. Correction of impact of transmitter mounting position on site – pressure reset .....	23
8.4. Correction of impact of spacing of distance separators on site .....	24
8.5. Flow measurements .....	24
8.6. Level measurements .....	24
8.7. Pressure and differential pressure measurements .....	25
<b>9. OPERATION</b> .....	<b>25</b>
9.1. Local LCD display .....	26
9.2. Local buttons .....	29
9.3. Local configuration of setpoints .....	29
9.4. Navigation in local setpoints MENU .....	29
9.5. Acceptance of local setpoints .....	29
9.6. Structure of local setpoints MENU .....	30
9.7. Remote configuration of setpoints (HART 5/HART 7) .....	31
9.7.1. Compatible devices .....	31
9.7.2. Compatible configuration software .....	31
9.7.3. Local HART communication jumper .....	31
<b>10. MAINTENANCE</b> .....	<b>31</b>
10.1. Periodic inspections .....	31

10.2. Non-periodic inspections.....	31
10.3. Cleaning/washing .....	31
10.4. Diaphragm cleaning.....	31
10.5. Spare parts .....	32
10.6. Repair.....	32
10.7. Returns.....	32
<b>11. SCRAPPING, DISPOSAL.....</b>	<b>32</b>
<b>12. HISTORY OF REVISIONS .....</b>	<b>32</b>

### LIST OF DRAWINGS

<b>Figure 1.</b> Set range and measurement limits.....	12
<b>Figure 2.</b> Examples of pressure transmitter installation .....	15
<b>Figure 3.</b> Examples of differential pressure transmitter installation .....	15
<b>Figure 4.</b> Examples of transmitter installation on tanks.....	15
<b>Figure 5.</b> Electrical connection to transmitter.....	17
<b>Figure 6.</b> Electrical connection 4...20 mA of HART to transmitter in standard version.....	18
<b>Figure 7.</b> Electrical connection 4...20 mA of HART to transmitter in Exd version .....	18
<b>Figure 8.</b> Electrical connection 4...20 mA of HART to transmitter in Exi version.....	19
<b>Figure 9.</b> Set range current, saturation currents, alarm currents of transmitters in Exd or Exi/Exd (also IS, XP, IS/XP) version .....	21
<b>Figure 10.</b> Set range current, saturation currents, alarm currents of transmitters in standard or Exi version .....	22
<b>Figure 11.</b> Rotation of the housing, change of display position and access to buttons.....	25
<b>Figure 12.</b> Display information fields.....	26
<b>Figure 13.</b> Local menu structure of transmitter .....	30

### LIST OF TABLES

<b>Table 1.</b> Definitions and abbreviations.....	11
<b>Table 2.</b> Symbols occurring on the transmitter nameplate .....	14
<b>Table 3.</b> Permissible transmitter supply voltages .....	19

## 1. INTRODUCTION

### 1.1. Purpose of the document

The subject of manual are smart pressure transmitters **APC-2000ALW**, smart differential pressure transmitters **APR-2000ALW**, **APR-2000ALW with diaphragm seals** (formerly APR-2200ALW), **APR-2000ALW/G** (formerly APR-2000GALW), hereinafter referred jointly to as the transmitters. The manual applies to the following versions: standard, PED, flameproof Exd (XP), intrinsically safe Exi (IS) and Exi/Exd (IS/XP).

Within the meaning of Directive 2014/68/EU (PED), the transmitters are designed to category I, module A. PED marking does not apply to additional equipment of the transmitters, i.e. separators, valves, connectors, impulse tubes, etc. In the manufacturer's EU declarations of conformity, the transmitters as designed above have the CE markings. The transmitters with permissible overload of 200 bar and lower are manufactured in accordance with good engineering practice according to article 4 point 3 of Directive 2014/68/EU.

The manual contains data, tips and general recommendations for safe installation and operation of the transmitters, as well as troubleshooting in case of possible failure.

The manual does not cover explosion protection issues.

The use of the equipment in hazardous zones without appropriate approvals is forbidden. It is mandatory to read:



- EN.IX.APC.APR.ALW Explosion-proof Device User Manual, containing important information related to the installation of intrinsically safe and flameproof versions of the transmitters;
- EN.FM.APC.APR.ALW Hazardous Area Installation Manual, containing important information related to the installation of intrinsically safe (IS) and explosionproof versions (XP) of the transmitters.

In addition, please refer to the Technical Information, which contains detailed technical data, parameters and recommendations for installation and operation.

### 1.2. Trademarks

HART® is a registered trademark of FieldComm Group.

Windows® is a registered trademark of Microsoft Corporation.

Google Play® is a service registered and managed by Google® Inc.

### 1.3. Definitions and abbreviations

**Table 1.** Definitions and abbreviations

Item no.	Abbr.	Meaning
1	<b>LRV</b>	"Lower Range Value" – the value of the set range expressed in physical units corresponding to the current of 4,000 mA, i.e. 0% of the output setpoint. The set range cannot exceed the set range limits. The minimum width of the set range <b>  (URV-LRV)  </b> is limited to 10% of the base range <b>(URL-LRL)</b> .
2	<b>URV</b>	"Upper Range Value" – the value of the set range expressed in physical units corresponding to the current of 20,000 mA, i.e. 100% of the output setpoint. The set range cannot exceed the set range limits. The minimum width of the set range <b>  (URV-LRV)  </b> is limited to 10% of the base range <b>(URL-LRL)</b> .
3	<b>LRL</b> <b>LSL</b>	"Lower Range Limit" or "Lower Sensor Limit" - lower limit of set range expressed in physical units. Value <b>(URL-LRL)</b> or <b>(USL-LSL)</b> is referred to as the base transmitter range.
4	<b>URL</b> <b>USL</b>	"Upper Range Limit" or "Upper Sensor Limit" – upper limit of set range expressed in physical units. Value <b>(URL-LRL)</b> or <b>(USL-LSL)</b> is referred to as the base transmitter range.
5	<b>LPL</b>	"Lower Processing Limit" – lower limit of digital processing of measured value. The transmitter processes a digital measurement up to 50% of the base range width below the lower limit of set range <b>LRL (LSL)</b> . After reaching the <b>LPL</b> and when below this value up to <b>LSAL</b> , the transmitter freezes the refreshing of digital value of the measurement. In this situation, for Exd (XP) or Exi/Exd version of transmitter, error number E0128 will be displayed on the display and diagnostic alarm mode <b>I_AL &lt; 3,600 mA</b> will be set. For standard or Exi transmitters, a message "UndEr" will be displayed, and diagnostic alarm mode will be activated depending on the settings <b>I_AL &lt; 3,650 mA</b> or <b>I_AL &gt; 21,500 mA</b> . Additionally, collective status <b>PV_OUT_OF_LIMITS</b> and status <b>PV_LOW_LIMITED</b> in the Transducer Block will be set, which can be read out in the diagnostic tab via HART communication.
6	<b>UPL</b>	"Upper Processing Limit" – upper limit of digital processing of measured value. The transmitter processes a digital measurement up to 50% of the base range width above the upper limit of set range <b>URL (USL)</b> . After reaching the <b>UPL</b> and when above this value up to <b>USAL</b> , the transmitter freezes the refreshing of digital value of the measurement. In this situation, for Exd or Exi/Exd (also IS, XP, IS/XP) version of transmitter, error number E0128 will be displayed on the display and diagnostic alarm mode <b>I_AL &lt; 3,600 mA</b> will be set. For standard or Exi transmitters, a message "OvEr" will be displayed and diagnostic alarm mode will be activated depending on the settings <b>I_AL &lt; 3,650 mA</b> or <b>I_AL &gt; 21,500 mA</b> . Additionally, collective status <b>PV_OUT_OF_LIMITS</b> and status <b>PV_HIGH_LIMITED</b> in the Transducer Block will be set, which can be read out in the diagnostic tab via HART communication.
7	<b>LSAL</b>	"Lower Saturation Limit" - lower limit of the A/D transmitter processing range. The lower limit of the A/D transmitter saturation is on the pressure / differential pressure scale below the <b>LPL</b> point and is associated with the minimum pressure, at which the analogue-digital pressure measurement transmitter reaches the lower limit of the processing capacity. The exact determination of this pressure is not possible, however usually the pressure does not exceed the pressure corresponding to 200% of the base range width <b>(URL-LRL)</b> below the lower limit of the digital processing of measured <b>LPL</b> value. After reaching <b>LSAL</b> and when below this value, error number E0136 will be displayed on the display and the diagnostic alarm mode <b>I_AL &lt; 3,600 mA</b> will be activated (applies to Exd or Exi/Exd (also IS, XP, IS/XP) version of transmitter). For standard or Exi transmitters, error number E0256 will be displayed and diagnostic alarm mode will be activated depending on the settings <b>I_AL &lt; 3,650 mA</b> or <b>I_AL &gt; 21,500 mA</b> . Additionally, collective status <b>SENSOR_FAULT</b> , <b>PV_OUT_OF_LIMITS</b> , status <b>NOREF+ERR@AIN1_AD7794</b> in the Sensor Block and <b>PV_LOW_LIMITED</b> in the Transducer Block will be set, which can be read out in the diagnostic tab via HART communication.
8	<b>USAL</b>	"Upper Saturation Limit" - upper limit of the A/D transmitter processing range. The upper limit saturation point of A/D transmitter is on the pressure / differential pressure scale above the <b>UPL</b> point and is associated with the maximum pressure at which the analogue-digital pressure measurement transmitter reaches the upper limit of the processing capacity. The exact determination of this pressure is not possible, however usually the pressure does not exceed the pressure corresponding to 200% of the base range width <b>(URL-LRL)</b> above the upper limit of the digital processing of measured <b>UPL</b> value. After reaching <b>USAL</b> and when above this value, error number E0136 will be displayed on the display and the diagnostic alarm mode <b>I_AL &lt; 3,600 mA</b> will be activated (applies to Exd or Exi/Exd (also IS, XP, IS/XP) version of transmitter). For standard or Exi transmitters, error number E0256 will be displayed and diagnostic alarm mode will be activated depending on the settings <b>I_AL &lt; 3,650 mA</b> or <b>I_AL &gt; 21,500 mA</b> . Additionally, collective status <b>SENSOR_FAULT</b> , <b>PV_OUT_OF_LIMITS</b> , status <b>NOREF+ERR@AIN1_AD7794</b> in the Sensor Block and <b>PV_HIGH_LIMITED</b> in the Transducer Block will be set, which can be read out in the diagnostic tab via HART communication.
9	<b>AL_L</b>	Low current alarm.
10	<b>AL_H</b>	High current alarm.
11	<b>I_AL</b>	The alarm current set by the transmitter controller in the current loop.

#### 1.4. Transmitter set range

The figure below shows the transmitter set range and limits related to allowable set range, digital processing range and saturation limits of A/D pressure measurement transducer. As standard, values of 4 mA/20 mA currents are assigned to LRV/URV points. In order to obtain reverse characteristics, it is possible to reverse the assignment so that the LRV/URV points are assigned to 20 mA/4 mA currents.

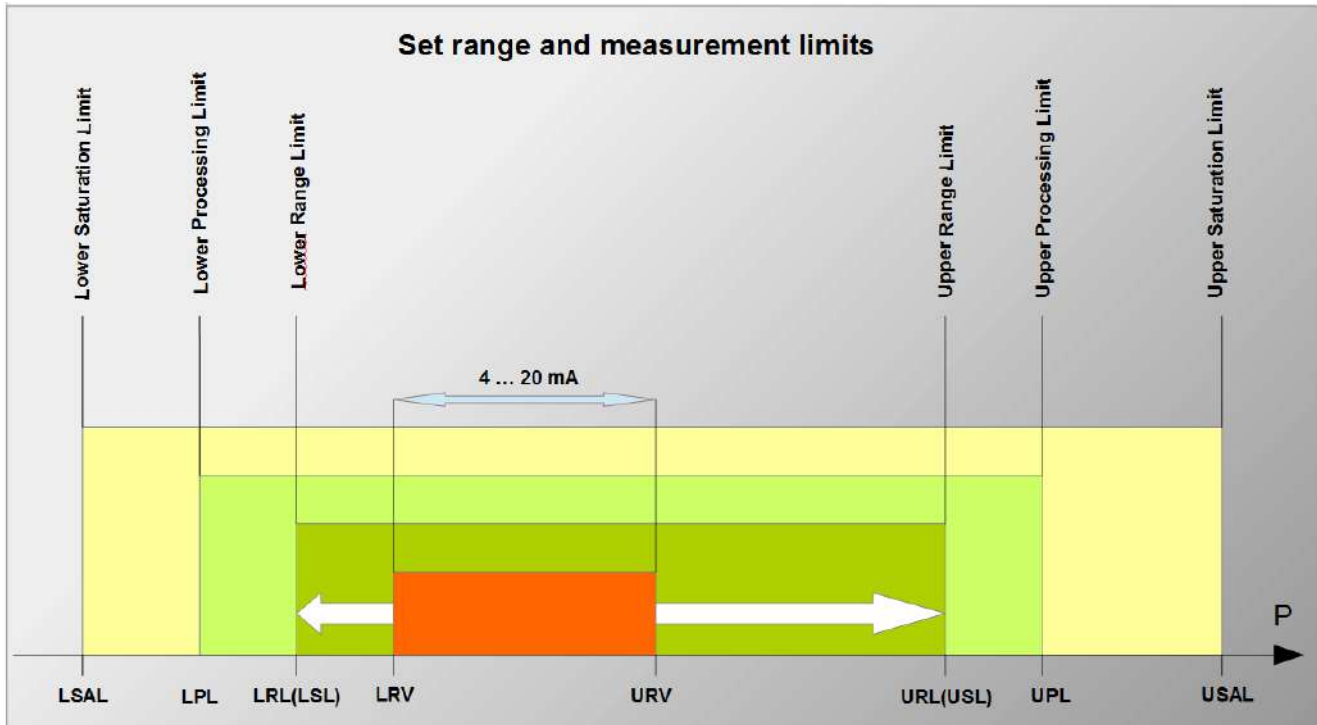


Figure 1. Set range and measurement limits

## 2. SAFETY



- The installation and start-up of the device and any activities related to operation shall be carried out after thorough examination of the contents of user's manual and the instructions related thereto.
- Installation and maintenance should be carried out by qualified staff having the required authorizations to install electrical and measuring devices.
- The device shall be used according to its intended purpose in line with the permissible parameters specified on the nameplate (→ [Transmitter identification](#)).
- The protection elements used by the manufacturer to ensure transmitter safety may be less effective if the device is operated in a manner not consistent with its intended purpose.
- Before installing or disassembling the device, it is absolutely necessary to disconnect it from the power source.
- No repairs or alterations to the transmitter electronic system are permitted. Assessment of damages and possible repair may only be performed by the manufacturer or authorized representative.
- Do not use instruments if damaged. In case of malfunction, the device must be put out of operation.
- In case of transmitters equipped with factory-mounted process connector of C and CR type, it is unacceptable to loosen the fixing screws of the connector cover.

## 3. TRANSPORT AND STORAGE

### 3.1. Delivery check

After receiving the delivery of the equipment, it is necessary to:

- make sure that the packaging and its contents were not damaged during transport;
- check the completeness and correctness of the received order, and make sure no parts are missing.

### 3.2. Transport

Transport of transmitters shall be carried out with the use of covered means of transport, in original packages with diaphragm provided with protection. The packaging shall be protected against movement and direct impact of atmospheric factors.

### 3.3. Storage

Transmitters shall be stored in a factory packaging, in a room without vapours and aggressive substances, protected against mechanical impact.

Allowable range of storage temperature:

-40...80°C (-40...176°F).

## 4. GUARANTEE

General terms and conditions of guarantee are available on the manufacturer's website:

[www.aplisens.com/ogolne\\_warunki\\_gwarancji](http://www.aplisens.com/ogolne_warunki_gwarancji).



The guarantee shall be repealed if the device is used against its intended use, failure to comply with user's manual or interference with the structure of the device.

## 5. IDENTIFICATION



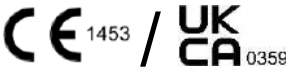






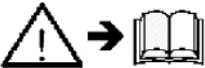
### 5.1. Manufacturer's address

APLISENS S.A.  
03-192 Warsaw  
Morelowa 7 St.  
Poland

### 5.2. Transmitter identification

Depending on the version of the transmitter, the nameplates may differ in the amount of information and parameters.

**Table 2.** Symbols occurring on the transmitter nameplate

	Logo and name of manufacturer
	CE/UKCA mark
	CE/UKCA mark with the number of notified body
	QR code
<b>TYPE:</b>	Transmitter type
<b>Process connection:</b>	Process connector
<b>ID:</b>	Transmitter model ID
 <b>P</b>	Measurement range
 <b>Tamb</b>	Permissible range of ambient temperature
 <b>PS</b>	Permissible static pressure
 <b>U</b>	Power supply voltage
 <b>I</b>	Output signal
<b>Mat.</b>	Material of wetted parts
<b>Ser.- No.</b>	Serial number
<b>Electrical connection</b>	Type of electrical connection
<b>Year of production</b>	Year of production
<b>IP</b>	IP protection rating
<b>//Lower part of the nameplate//</b>	Special execution
	Note about obligation to read the manual
<b>Aplisens S.A. ul. Morelowa 7, 03-192 Warszawa</b>	Manufacturer address

### 5.3. CE or UKCA mark and declaration of conformity

The device has been designed to meet the highest safety standards, has been tested and has left the factory in a condition that is safe for operation. The device complies with the applicable standards and regulations listed in EU and UK Declaration of Conformity. The CE or UKCA nameplate marking is dependent on delivery region of the transmitter.

## 6. INSTALLATION

### 6.1. General recommendations



In order to avoid measurement errors caused by the accumulation of condensate (in gas installations) or gas bubbles (in liquid installations) in impulse lines, assembly solutions using constructions based on available engineering knowledge should be used. For a gaseous medium, this may mean installing the transmitters above the pressure measuring point, and for liquids below this point. Differential pressure transmitters for gases APR-2000ALW/G should be obligatorily installed vertically.

#### 6.1.1. Examples of transmitter installation

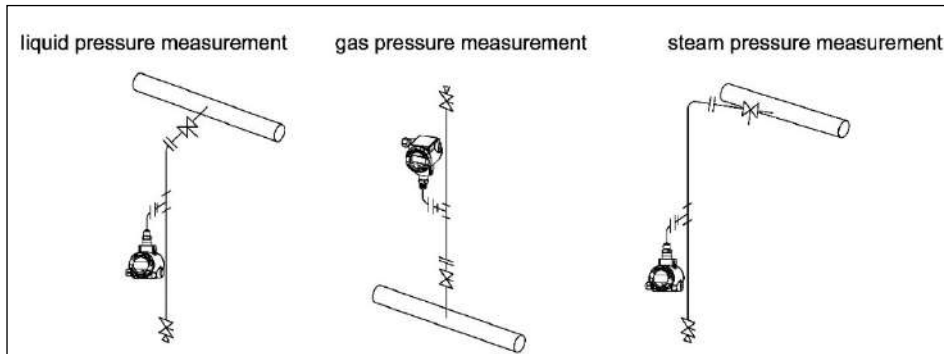


Figure 2. Examples of pressure transmitter installation

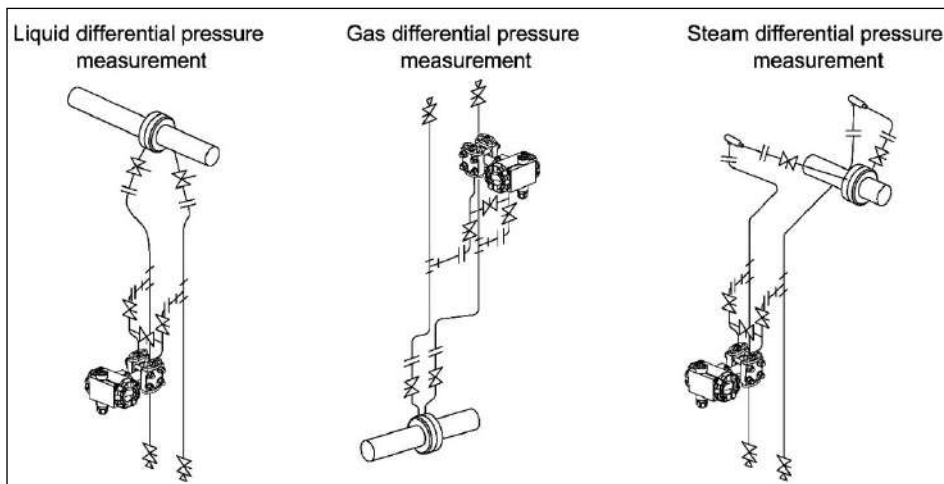


Figure 3. Examples of differential pressure transmitter installation

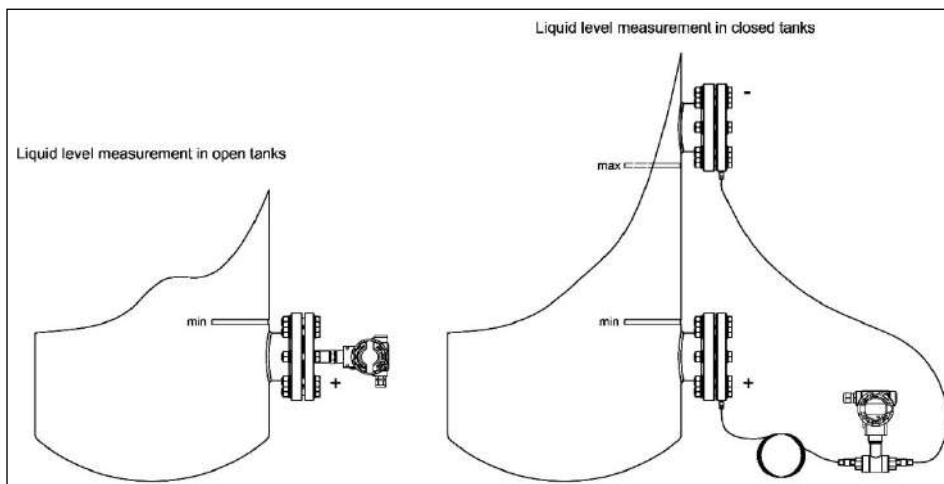


Figure 4. Examples of transmitter installation on tanks

#### 6.1.2. Installation instructions for transmitters with distance separators

The protection of the separator diaphragm can only be removed shortly before installation.

Hydrostatic pressure of the manometric liquid column in the transmitter-separator system may cause incorrect indication of the measured value. After installation, the transmitter must be pressure-reset. Do not clean or touch separator diaphragms using hard or pointy objects.



Separators with pressure transmitter form a closed, calibrated system filled with gauge fluid. The opening for filling the device with gauge fluid is sealed and must not be opened. When choosing a mounting location, it is necessary to ensure sufficient stress relief of the capillaries tension in order to avoid excessive bending. Incorrect installation of the sealing may result in incorrect measurement indications. Special attention must be paid when selecting correct dimensions of the sealing.



As standard, the separators are not provided with the gaskets.

## 7. ELECTRICAL CONNECTION

### 7.1. Cable connection to transmitter internal terminals



All connection and installation operations shall be performed with disconnected supply voltage and other external voltages, if used.

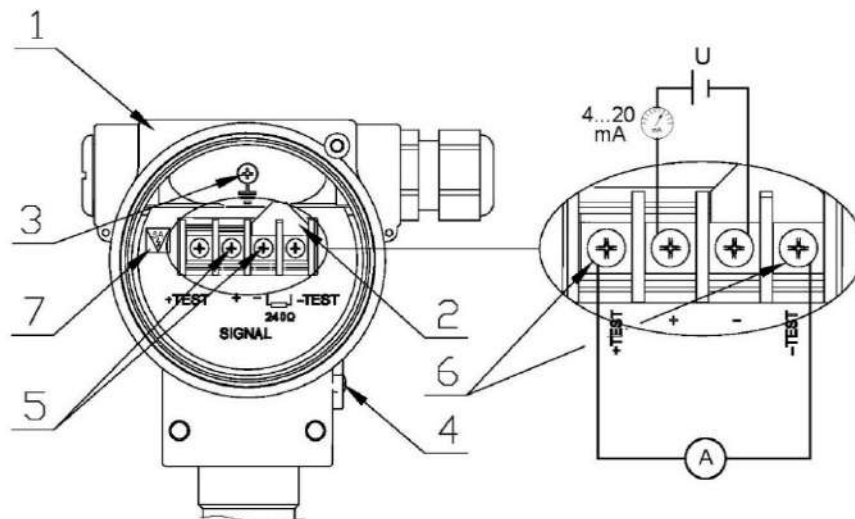


**Failure to provide proper connection of the transmitter may result in danger. Risk of electric shock and/or ignition in potentially explosive atmospheres.**

#### 7.1.1. Cable connection

In order to perform correct connection of the cables, the following steps shall be performed:

- disconnect power supply;
- unscrew the rear cover of the transmitter body to access the power connector;
- pull the cable through the cable gland;
- connect the transmitter according to the figure below, paying attention to the correct tightening of the bolts fixing the conductor core to the terminal;
- check the correct fixing of the HART local communication jumper;
- tighten the rear cover of the transmitter body;
- leaving a small clearance of the cable inside the body, tighten the gland nut so that the gland seal is clamped on the power cable.



**Figure 5.** Electrical connection to transmitter

1. Housing.
2. Jumper for local HART communication.
3. Internal ground terminal.
4. External ground terminal.
5. Transmitter power terminals, 4...20 mA current loop.
6. Ammeter connection terminals for uninterruptible current measurement (optional).
7. Designation SA variant with integrated overvoltage protection (applies to Exi version).



In hazardous zone, do not unscrew the housing covers after connecting the Exd flame-proof transmitter to the power source.

### 7.1.2. Connection of transmitter with the option of using local HART communication

The transmitter allows to use the local HART communication. To do this you can use a HART communicator unit or modem connected to a computer or a smartphone.

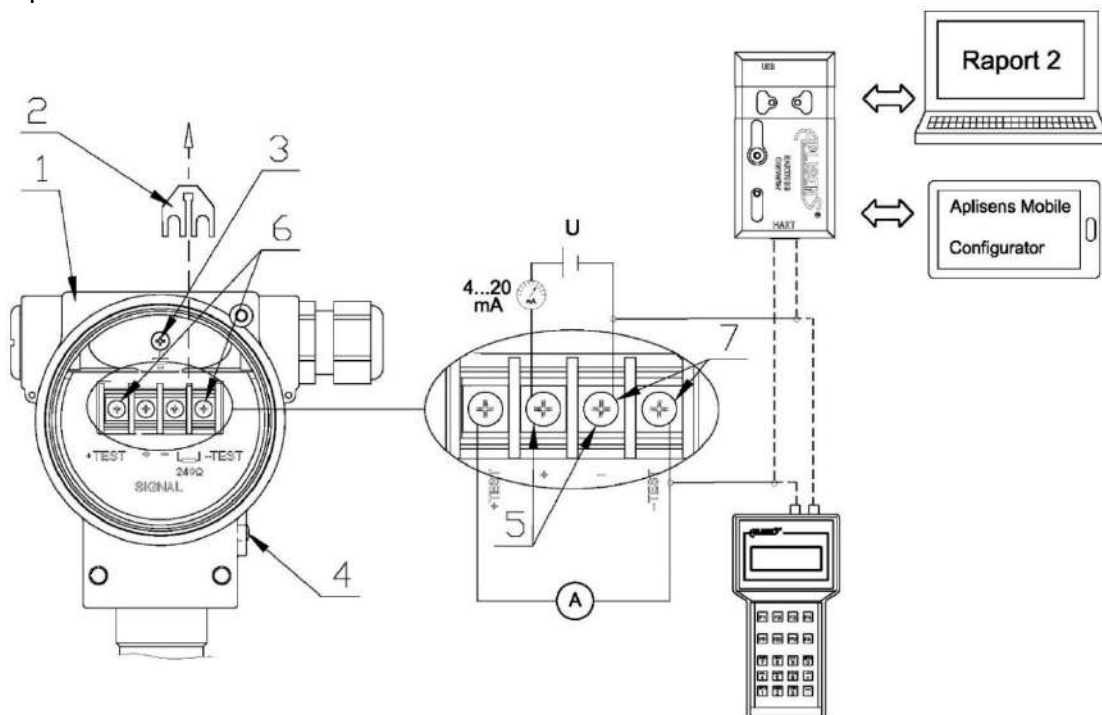
In order to establish the local communication, it is necessary to:

- remove HART communication jumper (item 2);
- connect the communicator or modem to electrical terminals (item 7).



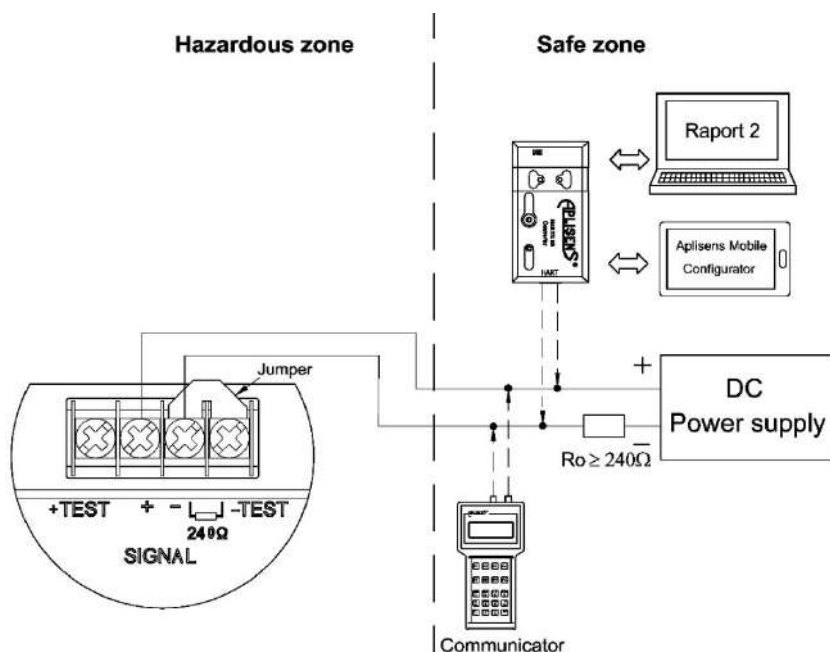
Opening of the HART jumper results in applying resistance of 240  $\Omega$  in series in line 4...20 mA. This resistance reduces voltage on transmitter supply terminals by approximately 5 V DC for Exd or Exi/Exd transmitters (5,28 V DC for standard or Exi transmitters) for maximum current that can be set by the transmitter. **To avoid the supply voltage deficit on the transmitter terminals, the HART jumper must be dismantled only for the time of performing the HART local communication.**

Connection diagram of the communicator or modem to transmitter power supply and measurement system is presented below:

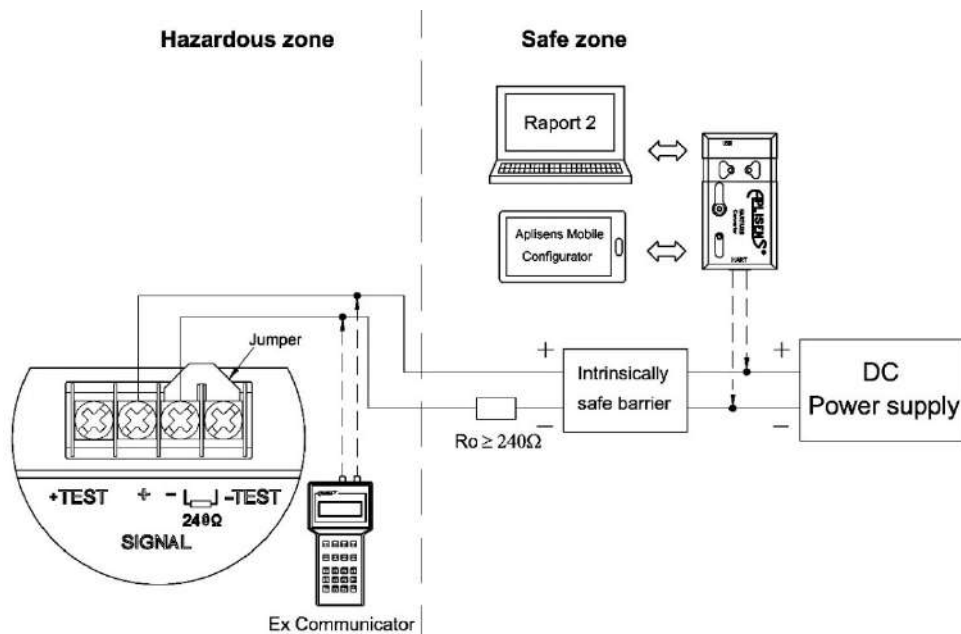


**Figure 6.** Electrical connection 4...20 mA of HART to transmitter in standard version

1. Housing.
2. Removed local HART communication jumper.
3. Internal ground terminal.
4. External ground terminal.
5. Transmitter power terminals, 4...20 mA current loop.
6. Ammeter connection terminals for uninterruptible current measurement (optional).
7. Terminals – point of connection of the communicator or HART modem.



**Figure 7.** Electrical connection 4...20 mA of HART to transmitter in Exd version



**Figure 8.** Electrical connection 4...20 mA of HART to transmitter in Exi version

It is mandatory to read:



- EN.IX.APC.APR.ALW Explosion-proof Device User Manual, containing important information related to the installation of intrinsically safe and flameproof versions of the transmitter;
- EN.FM.APC.APR.ALW Hazardous Area Installation Manual, containing important information related to the installation of intrinsically safe (IS) and explosionproof versions (XP) of the transmitter.

The converter may also be operated using **Aplisens Mobile Configurator** installed on smartphones with Android system and connected using wireless communication.

The software is available on Google Play®:

<https://play.google.com/store/apps/details?id=com.aplisens.mobile.amc>.

## 7.2. Transmitter power supply

### 7.2.1. Transmitter supply voltage



**Power cables may be live.  
There is a risk of electric shock and/or explosion.**



Installation of the transmitter in explosion-risk atmospheres must comply with national standards and regulations.

All explosion protection data is given in manual EN.IX.APC.APR.ALW.

**Table 3.** Permissible transmitter supply voltages

Version		Minimum supply voltage	Maximum supply voltage
Exi/Exd*	IS/XP**	11,5 V DC***	30 V DC (Exi, IS) 55 V DC (Exd, XP)
Exd*	XP**	13,5 V DC****	55 V DC
Standard		10,0 V DC	55 V DC
Exi*		10,5 V DC	30 V DC
IS**		11,5 V DC	30 V DC

\* For details on intrinsically safe and flameproof version see manual EN.IX.APC.APR.ALW.

\*\* For details on intrinsically safe (IS) and flameproof variant (XP) see manual EN.FM.APC.APR.ALW.

\*\*\* Minimum supply voltage with backlight off. Possibility of turning on the backlight only by manufacturer at the transmitter production stage (then  $U_{min}=14,5$  V DC).

\*\*\*\* Minimum supply voltage with backlight on. Possibility of turning off the backlight only by manufacturer at the transmitter production stage (then  $U_{min}=10,5$  V DC).

### 7.2.2. Uninterruptible current measurement in 4...20 mA current loop

The transmitter is capable of continuous current measurement in the current loop using an ammeter. In order to maintain the current measurement error below 0,05%, the internal resistance of the ammeter shall be less than 10 Ω.

Ammeter connection diagram – see: → [Figure 5. Electrical connection to transmitter.](#)

### 7.2.3. Specifications of electrical switching terminals

Internal electrical switching terminals are suitable for conductors with the cross-section from 0,5 to 2,5 mm<sup>2</sup>. The internal and external electrical ground terminal of the body is suitable for conductors with cross-section from 0,5 to 5 mm<sup>2</sup>.

### 7.2.4. Cabling specification

Aplisens S.A. recommends using two-wire screened twisted pair cable. The outer diameter of the cable shell from 5 to 9 mm is recommended.

### 7.2.5. Resistance load in power supply line

The power line resistance, power source resistance and other additional serial resistances increase the voltage drops between the power source and the transmitter terminals. The maximum current of IS, Exd, XP, Exi/Exd or IS/XP transmitters under normal operation conditions is defined as  $I_{max} = 20,500 \text{ mA} + E$ , where E is the acceptable safety error, which is  $\pm 0,160 \text{ mA}$ . The maximum current of standard or Exi transmitters under normal operation conditions is 20,500 mA, but during high alarm the value of current  $I_{max}$  is 22,000 mA.

The maximum resistance value in the power circuit (along with the power cables resistance) is defined by the formula:

$$R_{L\_MAX}[\Omega] \leq \frac{(U - U_{min}) [V]}{0,02066 [A]} \quad (\text{for transmitters in IS, Exd, Exi/Exd, IS/XP version})$$

$$R_{L\_MAX}[\Omega] \leq \frac{(U - U_{min}) [V]}{0,02200 [A]} \quad (\text{for transmitters in standard, Exi version})$$

where:

U – voltage at the supply terminals of the 4...20 mA current loop [V].

$U_{min}$  – minimum supply voltage of transmitter → [Table 3. Permissible transmitter supply voltages.](#)

$R_{L\_MAX}$  – maximum power supply line resistance [Ω].

### 7.2.6. Shielding, equipotential bonding

When using a cable in the screen, connect the screen on one side to ground, preferably in place where transmitter is powered.

## 7.3. Equipotential bonding

When using an intrinsically safe transmitter with an additional overvoltage protection, having the designation “SA version” on the plate, the transmitter should be powered from a galvanically separated power source or, if this is not possible, equipotential bonding of the transmitter and the power supply device should be ensured by means of equipotential bonding conductors. In this respect the locally applicable regulations must be observed.

## 7.4. Overvoltage protection

Transmitters comply with EMC standards for safety-related products used in general industrial environment. Transmitters in standard and flameproof versions are fitted with overvoltage protection. In intrinsically safe transmitters, in order to increase the resistance to excessive surge, it is possible to use the overvoltage protection **SA** version. Transmitters with integrated overvoltage protection **SA** should be grounded.

Overvoltage protection parameters in transmitters in standard, Exd, XP or SA versions:

- discharge threshold voltage: 230 V DC;
- discharge threshold impulse voltage: 450 V (impulse 100 V/μs);
- discharge threshold impulse voltage: 600 V (impulse 1000 V/μs);
- discharge current for 1 surge: 20 kA, 8/20 μs;
- discharge current for 10 surges: 10 kA, 8/20 μs;
- discharge current for 300 surges: 200 A, 10/1000 μs.

## 7.5. Final inspection of cabling

After completing the electrical installation of the transmitter it is necessary to check the following:

- does the supply voltage measured at the transmitter terminals at maximum set current match the range of supply voltage specified on the transmitter nameplate?
- Is the transmitter connected according to the information given in section → [Cable connection to transmitter internal terminals](#)?
- Are all the screws tightened?
- Are the transmitter covers tightened?
- Are the cable gland and the gland plug tightened?

## 8. START-UP

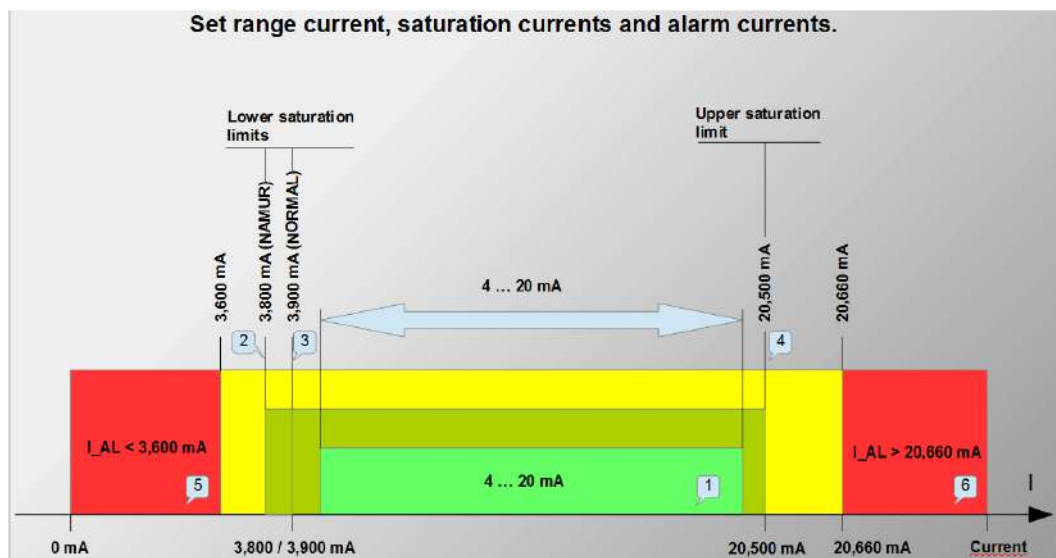
As standard, the transmitter is adjusted to a set range equal to the base range, unless a specific set range is provided in the order. The base range and the basic unit of the transmitter can be read out from its nameplate (→ [Transmitter identification](#)).



Use the transmitter within the allowable pressure limits. Risk of injury due to component breakage after exceeding the maximum permitted operating pressure.

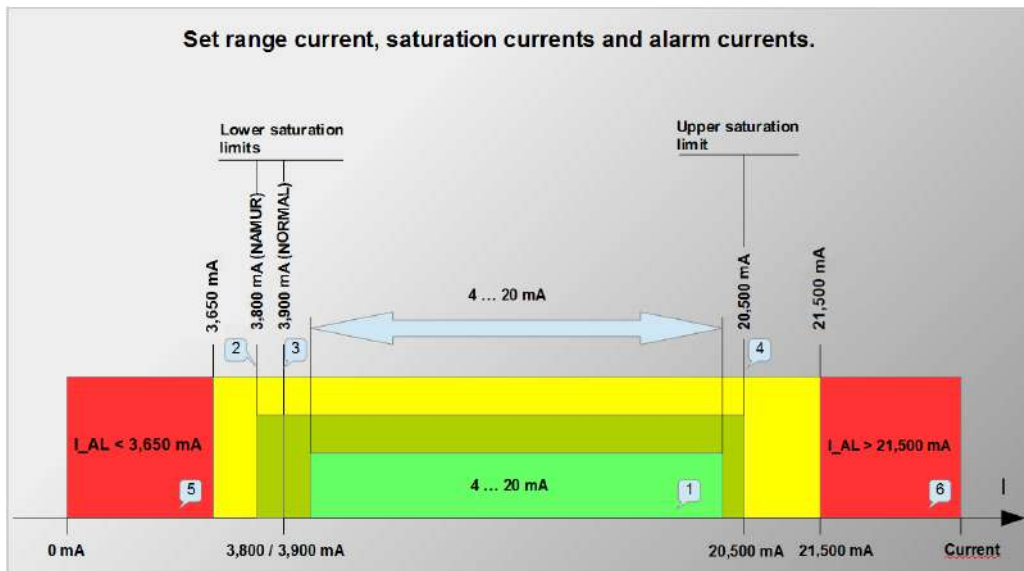
### 8.1. Alarm configuration

Transmitters has a developed internal diagnostics, which monitors the work of their electronic circuits, process and environmental parameters. For transmitters in Exd or Exi/Exd (also IS, XP, IS/XP) version, diagnosed dangerous states or malfunctions of the internal transmitter systems result in setting the alarm current  $I_{AL} < 3,600$  mA. For transmitters in standard or Exi version, diagnosed dangerous states or malfunctions of the internal transmitter systems result in setting the alarm current depending on the configuration  $I_{AL} < 3,650$  mA or  $I_{AL} > 21,500$  mA. The user has an option of enabling/disabling of the current alarms. Current alarms are disabled by default. The figures below shows the normal operation ranges of the transmitter process output and the ranges of saturation and alarm currents.



**Figure 9.** Set range current, saturation currents, alarm currents of transmitters in Exd or Exi/Exd (also IS, XP, IS/XP) version

- 1 - Set 4...20 mA current area is corresponding to setpoint 0...100% of the process output.
- 2 - Lower saturation current of 3,800 mA for NAMUR mode.
- 3 - Lower saturation current of 3,900 mA for NORMAL mode.
- 4 - Upper saturation current of 20,500 mA for NAMUR and NORMAL mode.
- 5 - Alarm current area  $I_{AL} < 3,600$  mA for internal diagnostic alarms.
- 6 - Alarm current area  $I_{AL} > 20,660$  mA for alarms related to safe failures with external diagnostics.



**Figure 10.** Set range current, saturation currents, alarm currents of transmitters in standard or Exi version

- 1 - Set 4...20 mA current area is corresponding to setpoint 0...100% of the process output.
- 2 - Lower saturation current of 3,800 mA for NAMUR mode.
- 3 - Lower saturation current of 3,900 mA for NORMAL mode.
- 4 - Upper saturation current of 20,500 mA for NAMUR and NORMAL mode.
- 5 - Alarm current area  $I_{AL} < 3,650$  mA for internal diagnostic alarms.
- 6 - Alarm current area  $I_{AL} > 21,500$  mA for internal diagnostic alarms.

**The transmitter diagnostics continually tests the environmental parameters:**

- Temperature of the pressure measurement structure sensor.
- Temperature of the ADC transducer converting the electric signal from the pressure sensor to the digital value of measurement.
- Temperature of the CPU structure (transmitter's main microcontroller). For transmitters in Exd or Exi/Exd (also IS, XP, IS/XP) version, if the operating temperature limits are exceeded, the diagnostics will trigger an alarm  $I_{AL} < 3,600$  mA. Temperature return to permissible range of the transmitter operation will result in deactivation of the diagnostic alarm mode and return to normal operation. For transmitters in standard or Exi version, if alarms from 2, 3 and 4 process variable (temperatures) are enabled, when the transmitter operating temperature limits are exceeded, the diagnostics will trigger an alarm depending on the settings  $AL_L < 3,650$  mA or  $AL_H > 21,500$  mA. Temperature return to permissible range of the transmitter operation will result in deactivation of the diagnostic alarm mode and return to normal operation.

**The transmitter diagnostics continually tests the pressure process parameters:**

- If the pressure/differential pressure value increases above 50% of the base range width from URL point reaching the UPL point, the diagnostics of transmitter in Exd or Exi/Exd (also IS, XP, IS/XP) version will trigger an alarm  $I_{AL} < 3,600$  mA. The return of the pressure / differential pressure below the UPL point will result in deactivating the alarm and returning the transmitter to its normal operation. In case of transmitters in standard or Exi version, if the pressure / differential pressure value increases to the upper limit of ADC measurement converting transducer, reaching the USAL point, the diagnostics will trigger an alarm depending on the configuration  $AL_L < 3,650$  mA or  $AL_H > 21,500$  mA. The return of the pressure / differential pressure below the USAL point will result in deactivating the alarm and returning the transmitter to its normal operation.
- If the pressure / differential pressure value decreases below 50% of the base range width from LRL point reaching the LPL point, the diagnostics of transmitter in Exd or Exi/Exd (also IS, XP, IS/XP) version will trigger an alarm  $I_{AL} < 3,600$  mA. The return of the pressure / differential pressure above the LPL point will result in deactivating the alarm and returning the transmitter to its normal operation. In case of transmitters in standard or Exi version, if the pressure / differential pressure value decreases to the lower limit of ADC measurement converting transducer, reaching the LSAL point, the diagnostics will trigger an alarm depending on the configuration  $AL_L < 3,650$  mA or  $AL_H > 21,500$  mA. The return of the pressure / differential pressure above the LSAL point will result in deactivating the alarm and returning the transmitter to its normal operation.

## The transmitter diagnostics continually tests electric parameters and software resources of transmitter:

- If the inner diagnostics detects the malfunctioning or failure of the transmitter which are not critical with regard of integrity of hardware and software – software of the transmitter in Exd or Exi/Exd (also IS, XP, IS/XP) version will activate alarm I<sub>AL</sub> < 3,600 mA. The diagnostic alarm condition will continue until the failure or damage is resolved. Error/failure number **Exxxx** will appear on LCD2; the **ERROR** message will be displayed on LCD3. The image will blink to attract the operator's attention. The transmitter will set the current output to alarm status I<sub>AL</sub> < 3,600 mA. In case of transmitter in standard or Exi version, software will activate alarm depending on the configuration AL<sub>L</sub> < 3,650 mA or AL<sub>H</sub> > 21,500 mA. The diagnostic alarm condition will continue until the failure or damage is resolved. Error/failure number **Exxxx** will appear on LCD2; the **ERROR** message will be displayed on LCD3. The image will blink to attract the operator's attention.
- If the internal diagnostics detects malfunctioning or failure of the transmitter which are critical from the point of view of integrity of hardware and software, such as the hardware error of RAM, FLASH, SVS, CPU logs, mathematical computation error, or if there is a difference exceeding 1% between the set process current and the current measured in the line, the transmitter will immediately stop operation and activate the critical diagnostic alarm mode. The transmitter display will be switched off. HART communication with the transmitter will not be possible. In case of transmitter in Exd or Exi/Exd (also IS, XP, IS/XP) version, in the critical diagnostic alarm mode the additional protection of the transmitter disconnects its power supply from loop 4...20 mA. In such a case, alarm current I<sub>AL</sub> is much lower than 3,600 mA and is less than 0,500 mA. The transmitter will remain in OFF state until the power is disconnected and the transmitter is switched on again. In case of transmitter in standard or Exi version, in the critical diagnostic alarm mode the additional protection of the transmitter will lower the current in the loop 4...20 mA. In such a case, alarm current I<sub>AL</sub> is much lower than 3,650 mA, amounting about 0,150 mA. The transmitter will remain in the critical alarm status for approx. 10 seconds, then it will attempt to restart. When the internal diagnostics detects no hardware errors after restart, the transmitter will return to normal operation.

## 8.2. Configuration of operating mode

Before starting the work with the transmitter, the following parameters must be configured:

- basic unit of transmitter;
- processing characteristics;
- the beginning of the set LRV range;
- the end of the set URV range;
- damping time constant;
- NORMAL/NAMUR analogue output operation mode;
- analog output operation mode in alarm status AL<sub>L</sub>/AL<sub>H</sub> (applies to transmitters in standard or Exi version);
- alarm mode for indicating environmental events and defects;
- transmitter tag (TAG/LONG\_TAG);
- LCD display configuration parameters;
- setting of the settings change lock password.

## 8.3. Correction of impact of transmitter mounting position on site – pressure reset

Once the transmitter is mounted in a target location, it must be reset. This operation will eliminate the possible influence of the mounting position on the indication of pressure / differential pressure. In order to do so:

- in case of relative pressure transmitter without pressure supplied (vented), perform the pressure reset operation using the local MENU or HART communication;
- in the case of a differential pressure transmitter, at compensated pressures on the L and H supply, perform the pressure reset operation by means of local MENU or HART communication;
- in case of absolute pressure transmitter the resetting is only possible with an absolute pressure calibration device. Otherwise an attempt to reset the transmitter will display an error.

#### 8.4. Correction of impact of spacing of distance separators on site

In pressure / differential pressure transmitters with distance separator(s), it is required to make an adjustment depending on the impact of the separator position. The adjustment is made after the transmitter has been installed on site, before filling the plant. To do this, select "SETLRV" and "BYPRES" in the transmitter menu. Upon acknowledgement ("DONE"), a 4 mA signal, including the impact of the separator positions, is set in the transmitter. The 20 mA signal is set by selecting "SETURV". For level measurements, fill the tank to a level corresponding to 20 mA, select "BYPRES" and confirm. If it is not possible to fill the tank/plant to the value corresponding to the 20 mA signal, the URV value may be set by selecting "BYVALU" function and entering the value. The value (in pressure units) is calculated by adding the planned measurement span value to the pressure value (PV) obtained after setting the LRV signal (4 mA).

**Once the transmitter parameters have been entered and it has been reset at the workstation, it is required to:**

- **Secure the device against the possibility of making changes in the local setpoint change MENU.**
- **Set your own password different from default password of "00000000". The new password may consist of any combination of 8 hexadecimal characters 0...9, A...F. Store the password in a safe place. If the password is lost, its restoration or resetting to factory settings may only be performed by the manufacturer.**
- **Activate the setpoint change lock to secure the transmitter against accidental, unintentional change of parameters.**

Pressure reset can be done via local setpoint change MENU or HART communication. The remaining operations described in this section may only be performed using HART communication.



For Exd or Exi/Exd (also IS, XP, IS/XP) type transmitters, opening the housing cover in the hazardous zone in order to use the local setpoint change MENU is forbidden.

#### 8.5. Flow measurements

Differential pressure transmitter APR-2000ALW can be used for venturi flow measurements. Flow measurements often require setting of pressure-processing characteristics for output current setpoints other than linear. In APR-2000ALW transmitter the following characteristics are available for the user:

- linear characteristics;
- second-stage root characteristics with relay characteristics and 0,2% hysteresis in the deadband
- manufacturer's dual linear characteristics No.1+ second-stage root characteristics for constant deadband = 0,6% of setpoints;
- manufacturer's single linear characteristics No.2+second-stage root characteristics and 0,2% hysteresis in the deadband;
- square characteristics;
- special characteristics based on user-modified table.

#### 8.6. Level measurements

Transmitters APC-2000ALW, APR-2000ALW, APR-2000ALW with diaphragm seals can be used for liquid level measurement in open or closed tanks. Examples of transmitter installation are shown in [→ Figure 4. Examples of transmitter installation on tanks.](#)

The transmitter can be configured in physical units of liquid column such as water and mercury at several temperatures of the liquid. It is also possible to enter the user's unit and perform any scaling of the setpoint indication. In case of tanks with irregular shapes, it is possible to use the user's characteristics to compensate the effect of the shape on the converted volume of liquid in the tank.

## 8.7. Pressure and differential pressure measurements

The APC-2000ALW transmitter is intended for measuring the relative (overpressure and underpressure) and absolute gas, vapour and liquid pressure. Examples of transmitter installation are shown in → [Figure 2. Examples of pressure transmitter installation.](#)

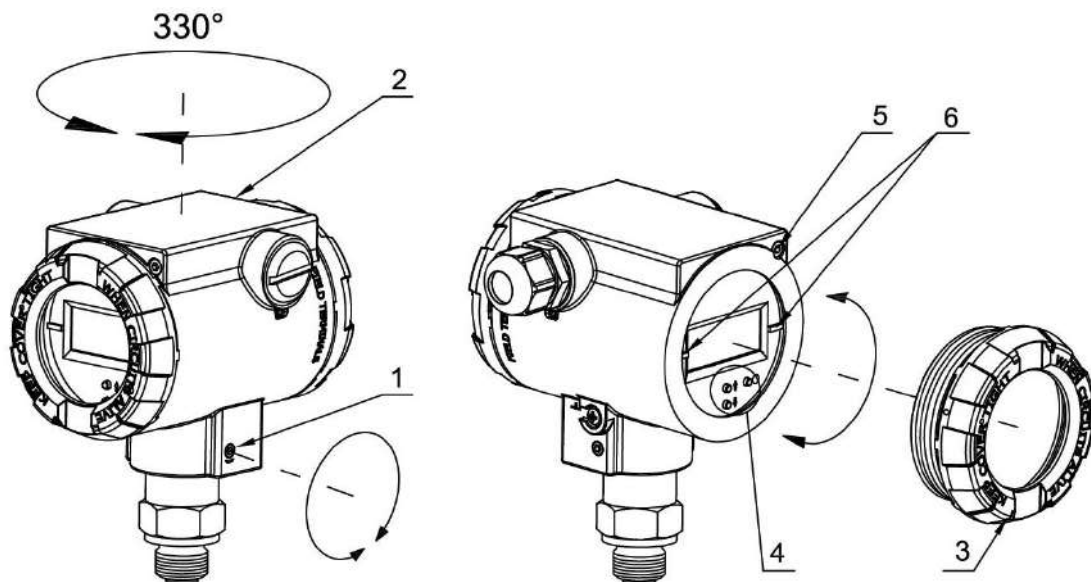
The transmitters APR-2000ALW and APR-2000ALW with diaphragm seals measure differential pressure on orifices, impact pressure tubes, filters, level in pressure tanks, etc. Examples of transmitter installation are shown in → [Figure 3. Examples of differential pressure transmitter installation.](#)

The transmitter may be configured for one of many physical units of pressure. It is also possible to enter the user's unit and perform any scaling of the setpoint indication.

For more issues regarding pressure, vacuum, differential pressure, level, flow measurements, refer to the Technical Information.

## 9. OPERATION

The transmitter gives the possibility of rotating the housing and adjusting the display position to the mounting position of the body. To rotate the housing, loosen the screw (item 1), position the transmitter housing (item 2) as required, tighten the screw (item 1). Access to the extensions (item 6) used to rotate the display is provided after tightening blocking screw (item 5) and opening the front cover (item 3). The display can be rotated by 345° with 15° step.



**Figure 11.** Rotation of the housing, change of display position and access to buttons

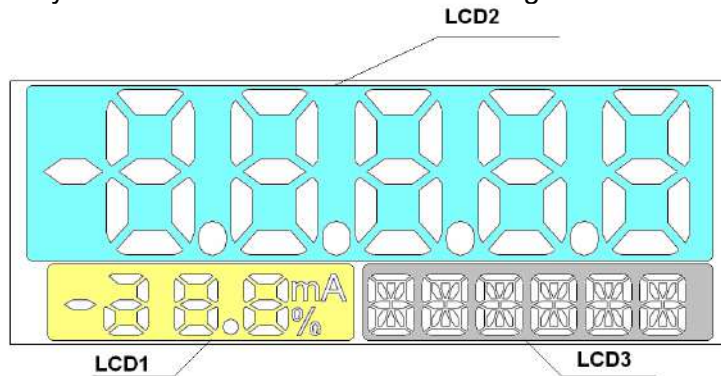
1. Screw blocking transmitter rotation.
2. Transmitter housing.
3. Front cover.
4. Local buttons.
5. Screw blocking front cover unscrewing.
6. Extensions for display rotation.



In hazardous zone, do not unscrew the housing covers after connecting the Exd, XP flameproof transmitter to the power source.

## 9.1. Local LCD display

The LCD has three primary information fields identified in the figure below as LCD1, LCD2, LCD3.



**Figure 12.** Display information fields

### LCD1 field:

**[mA]** - value (milliamperes) of process current in line 4...20 mA, proportional to the measured pressure.

**[%]** - value (percentage) of the setpoint  $U(t)$  of current controller in current loop 4...20 mA. This value is the ratio of the process current  $I_p(t)$  to the current range width according to the following formula:

$$\%U_{(t)} = \frac{I_{p(t)} - 4 \text{ [mA]}}{16 \text{ [mA]}} \cdot 100[\%]$$

### LCD2 field:

The LCD2 field is used mainly to display floating point decimal values in a unit displayed on LCD3. In some cases, other messages may be displayed:

- **ERROR** in case of some operating errors or failure diagnosed in the transmitter, error/failure number **Exxxx** will appear on LCD2, the **ERROR** message will be displayed on LCD3. The image will blink to attract the operator's attention. The transmitter in Exd or Exi/Exd (also IS, XP, IS/XP) version will set the current output to alarm status  $I_{AL} < 3,600$  mA. The transmitter in standard or Exi version will set the current output to alarm status depending on the configuration  $I_{AL} < 3,650$  mA or  $I_{AL} > 21,500$  mA. In order to identify the cause, please refer to the chapter "**Troubleshooting**" placed in Technical Information;
- **undEr** if the limit below LRV of the set range (only in MID mode) is exceeded by the process, the LCD1 display of transmitter in Exd or Exi/Exd (also IS, XP, IS/XP) version will show the message **undEr** (under). The image will blink to attract the operator's attention. The transmitter will set the current output to alarm status  $I_{AL} < 3,600$  mA. For transmitters in standard or Exi version, the message will appear when 50% of the base range below the lower limit range of the set LRL (LSL) is exceeded. After reaching the LPL and when below this value up to LSAL, the transmitter freezes the refreshing of digital value of the measurement. In this situation, message "UndEr" will be displayed. The image will blink to attract the operator's attention. The diagnostic alarm mode will be enabled depending on the settings  $I_{AL} < 3,650$  mA or  $I_{AL} > 21,500$  mA. Additionally, common status PV\_OUT\_OF\_LIMITS and status PV\_LOW\_LIMITED in the Sensor Block will be set, which can be read out in the diagnostic tab via HART communication. If the limit below LRV of the set range (only in MID mode) is exceeded by the process, **undEr** (under) message will appear on LCD1. The image will blink to attract the operator's attention. The transmitter will set the current output to alarm status depending on the configuration  $I_{AL} < 3,650$  mA or  $I_{AL} > 21,500$  mA;

- **ouEr** if the limit above URV of the set range (only in MID mode) is exceeded by the process, the LCD1 display of transmitter in Exd or Exi/Exd (also IS, XP, IS/XP) version will show the message **ouEr** (over). The image will blink to draw the operator's attention. For transmitters in standard or Exi version, the message will appear when 50% of the base range above the upper limit range of the set URL (USL) is exceeded. After reaching the UPL and when above this value up to USAL, the transmitter freezes the refreshing of digital value of the measurement. In this situation, the message "ovEr" will be displayed. The image will blink to attract the operator's attention.

The diagnostic alarm mode will be enabled depending on the settings  $I\_AL < 3,650 \text{ mA}$  or  $I\_AL > 21,500 \text{ mA}$ . Additionally, common status PV\_OUT\_OF\_LIMITS and status PV\_HIGH\_LIMITED in the Sensor Block will be set, which can be read out via HART communication. If the limit above URV of the set range (only in MID mode) is exceeded by the process, **ouEr** (over) message will appear on LCD1. The image will blink to draw the operator's attention. The transmitter will set the current output to alarm status depending on the configuration  $I\_AL < 3,650 \text{ mA}$  or  $I\_AL > 21,500 \text{ mA}$ ;

- ● ● ● ● when the set position of comma (point) on LCD2 does not allow for the correct display of the process variable, four dots ● ● ● ● will appear on LCD. The image will blink to attract the operator's attention. In this situation, change the decimal point position in the local setpoint change MENU or via HART communication.

### LCD3 field:

#### Abbreviations of physical units of pressures and levels and their description:

<b>INH2O</b>	inches of water column with temperature of 0°C	<b>PA</b>	pascals
<b>INGH</b>	inches of mercury column with temperature of 0°C	<b>KPA</b>	kilopascals
<b>FTH2O</b>	feet of water column with temperature of 20°C (68°F)	<b>TORR</b>	torrs
<b>MMH2O</b>	millimeters of water column with temperature of 20°C (68°F)	<b>ATM</b>	atmosphere
<b>MMHG</b>	millimeters of mercury column with temperature of 0°C	<b>MH2O4</b>	meters of water column with temperature of 4°C
<b>PSI</b>	pounds per square inch	<b>MPA</b>	megapascals
<b>BAR</b>	bars	<b>INH2O4</b>	inches of water column with temperature of 4°C
<b>MBAR</b>	millibars	<b>MMH2O4</b>	millimeters of water column with temperature of 4°C
<b>GSQCM</b>	grams per square centimeter	<b>NOUNIT</b>	the shortcut displayed when a unit not implemented in the transmitter is configured via HART communication
<b>KGSQCM</b>	kilograms per square centimeter		

#### Abbreviations of temperature measurement point name:

- SENS °C** Temperature of pressure / differential pressure sensor measurement structure in degrees Celsius.
- CPU °C** Temperature of the main CPU structure in degrees Celsius.

## Abbreviations displayed during configuration via local MENU and their descriptions:

<b>&lt;-BACK</b>	Return to one level above in local MENU.
<b>EXIT</b>	Going out of the local MENU.
<b>UNIT</b>	Pressure and level unit selection menu.
<b>SENS_T</b>	Option of measuring the temperature of pressure / differential pressure sensor measurement structure.
<b>CPU_T</b>	Option of measuring the main CPU structure temperature.
<b>DAMPIN</b>	Menu of selecting damping time constant of process variable.
<b>TRANSF</b>	Menu of selecting the current output linearization function.
<b>%SQRT</b>	Menu of selecting the deadband percentage of the root characteristics of the current output linearization.
<b>PVZERO</b>	Pressure transmitter resetting menu and option.
<b>SETURV</b>	URV setting menu (upper pressure of the set range).
<b>SETLRV</b>	LRV setting menu (lower pressure of the set range).
<b>BYPRES</b>	Option of setting the range according to pressure.
<b>BYVALU</b>	Option of setting the set range by entering a value.
<b>RESET</b>	transmitter hot restart software menu
<b>LCD1VR</b>	Menu for selection of the type of measurement displayed on LCD1.
<b>LCD2VR</b>	Menu for selection of the type of measurement displayed on LCD2.
<b>LCD2DP</b>	Menu for selecting position of comma/decimal point.
<b>FACTOR</b>	Return to factory values menu.
<b>RECALL</b>	Option of return to factory settings. Factory pressure / differential pressure calibrations, zero setpoints of pressure and current will be restored.
<b>LINEAR</b>	Option of linear function of current output setpoint linearization.
<b>SQRT</b>	Option of root function of current output setpoint linearization.
<b>SPECIA</b>	Option of the user's special characteristics of current output setpoint linearization.
<b>SQUARE</b>	Option of square function of current output setpoint linearization.
<b>CURREN</b>	Option of selecting the display of set current on LCD1.
<b>PERCEN</b>	Option of selecting the display of set percentage on LCD1.
<b>PRESS</b>	Option of selecting the display of pressure / differential pressure on LCD2.
<b>USER</b>	Option of selecting user's units and scaling to be displayed on LCD3.
<b>MID_WP</b>	MID mode setting menu. In this mode, the option of changing the setpoints related to the transmitter metrology is disabled. Additionally for Exd or Exi/Exd (also IS, XP, IS/XP) versions, exceeding of LRV and URV limits results in displaying undEr or ouEr message, blinking of the display and setting of the process output to the current alarm mode I <sub>AL</sub> < 3,600 mA. For standard or Exi transmitters, the exceeding of LRV and URV limits results in displaying the undEr or ouEr message, blinking of the display and setting of the process output to the current alarm mode depending on the configuration I <sub>AL</sub> < 3,650 mA or I <sub>AL</sub> > 21,500 mA.
<b>ON</b>	MID mode activation option.
<b>OFF</b>	MID mode deactivation option.
<b>X.XXXX</b>	Option of selecting position of comma/decimal point.
<b>XX.XXX</b>	Option of selecting position of comma/decimal point.
<b>XXX.XX</b>	Option of selecting position of comma/decimal point.
<b>XXXX.X</b>	Option of selecting position of comma/decimal point.
<b>XXXXX.</b>	Option of selecting position of comma/decimal point.
<b>0 [S]</b>	Option of selecting damping time constant.
<b>2 [S]</b>	Option of selecting damping time constant.
<b>5 [S]</b>	Option of selecting damping time constant.
<b>10 [S]</b>	Option of selecting damping time constant.
<b>30 [S]</b>	Option of selecting damping time constant.
<b>60 [S]</b>	Option of selecting damping time constant. The 60-second damping constant is only available from the local keypad; the configuration via HART in revision 5 does not allow a damping value greater than 30 seconds. Other damping values are possible to be set via HART communication.
<b>0.0 %</b>	Option of selecting root characteristics deadband point.
<b>0.2 %</b>	Option of selecting root characteristics deadband point.
<b>0.4 %</b>	Option of selecting root characteristics deadband point.
<b>0.6 %</b>	Option of selecting root characteristics deadband point.
<b>0.8 %</b>	Option of selecting root characteristics deadband point.
<b>1.0 %</b>	Option of selecting root characteristics deadband point.
	Other deadband values are possible to be set via HART communication.
<b>DONE</b>	Message about the acceptance and implementation of the set-point change.

## Abbreviations of local configuration errors and description of abbreviations:

<b>ER_L07</b>	Message displayed on LCD3. It is displayed if a user tries to change the setpoint in the transmitter protected against entry (change of setpoints) or in active MID mode. Message displayed on LCD3. It is displayed if:
<b>ER_L09</b>	<ul style="list-style-type: none"><li>– a user tries to change the set range by set pressure which is not within the allowable upper URL pressure;</li><li>– a user tries to pressure reset when the pressure exceeds the allowable upper limit.</li></ul>
<b>ER_L10</b>	Message displayed on LCD3. It is displayed if: <ul style="list-style-type: none"><li>– a user tries to change the set range by set pressure which is not within the allowable lower LRL pressure;</li><li>– a user tries to pressure reset when the pressure exceeds the allowable lower limit.</li></ul>
<b>ER_L14</b>	Message displayed on LCD3. It is displayed if: <ul style="list-style-type: none"><li>– the adopted URV value through the set pressure or entry of a value cannot be accepted because it causes a reduction of the set pressure range set below the allowable limit.</li></ul>
<b>ER_L16</b>	Message displayed on LCD3. It is displayed if: <ul style="list-style-type: none"><li>– a user tried to perform an operation that is disabled or unavailable. It may be caused by:<ul style="list-style-type: none"><li>– attempting to access the local setpoint change MENU when the access to the local MENU is disabled;</li><li>– attempting to pressure reset in the absolute pressure measurement transmitter.</li></ul></li></ul>
<b>WG_L14</b>	The message will appear if the assumed LRV value through the set pressure or entry of a value causes a decrease of the current set range. Entry of LRV automatically results in the transmitter's attempt to set URV in such a way that the current width of the set range is maintained. If this is not possible due to exceeded URL, the transmitter automatically adopts the URV=URL value and a new LRV value. Since the set range width and URV deviate from previous values, a message is displayed.

## ASCII characters displayed on LCD3 in user's unit:

Using HART communication, the user can configure its own 6-character unit displayed on LCD3. It is possible to display ASCII characters from the range 32...96 dec or 20...60 hex, i.e.:

!"#\$%&'()\*+,-./0123456789:;<=>?@ABCDEFGHIJKLMNPOQRSTUVWXYZ[\]^\_`

### 9.2. Local buttons

Local buttons are used to enable the configuration mode of some transmitter parameters and to navigate through MENU and accept MENU options. The MENU can be accessed by pressing and holding any of the buttons for at least 4 seconds. After this time, the LCD3 field of the local display will show an **EXIT** message. This signals entering into the MENU navigation mode.

### 9.3. Local configuration of setpoints

Transmitter enables local configuration of some of the most common setpoints via local buttons and local LCD display.

### 9.4. Navigation in local setpoints MENU

The MENU can be accessed by pressing and holding any of the buttons for at least 4 seconds. After this time, the LCD3 field of the local display will show an **EXIT** message. This signals entering into the local configuration MENU. By pressing the buttons with arrows [↑] [↓] for at least 1 second you can move up or down in MENU.

### 9.5. Acceptance of local setpoints

The button marked with symbol [●] is used to accept the selection. The acceptance of setpoint change is confirmed by a **DONE** message displayed on LCD3. After changing the setpoint, the transmitter leaves the local configuration change MENU. If no selection is made in the MENU mode, after 2 minutes the transmitter automatically returns to display of standard messages. The MENU can also be left by selecting and accepting the **EXIT** option.

### 9.6. Structure of local setpoints MENU

Press and hold any of 3 buttons for 4 seconds.

When navigating in the area of the active local MENU, holding the button required to trigger the action is minimum 1 second. Continuous pressing of the ↑ or ↓ button results in scrolling of the MENU positions every 1 second. If the local MENU remains inactive for more than 2 minutes, after this time the transmitter will automatically leave the MENU mode and will display the process variable.

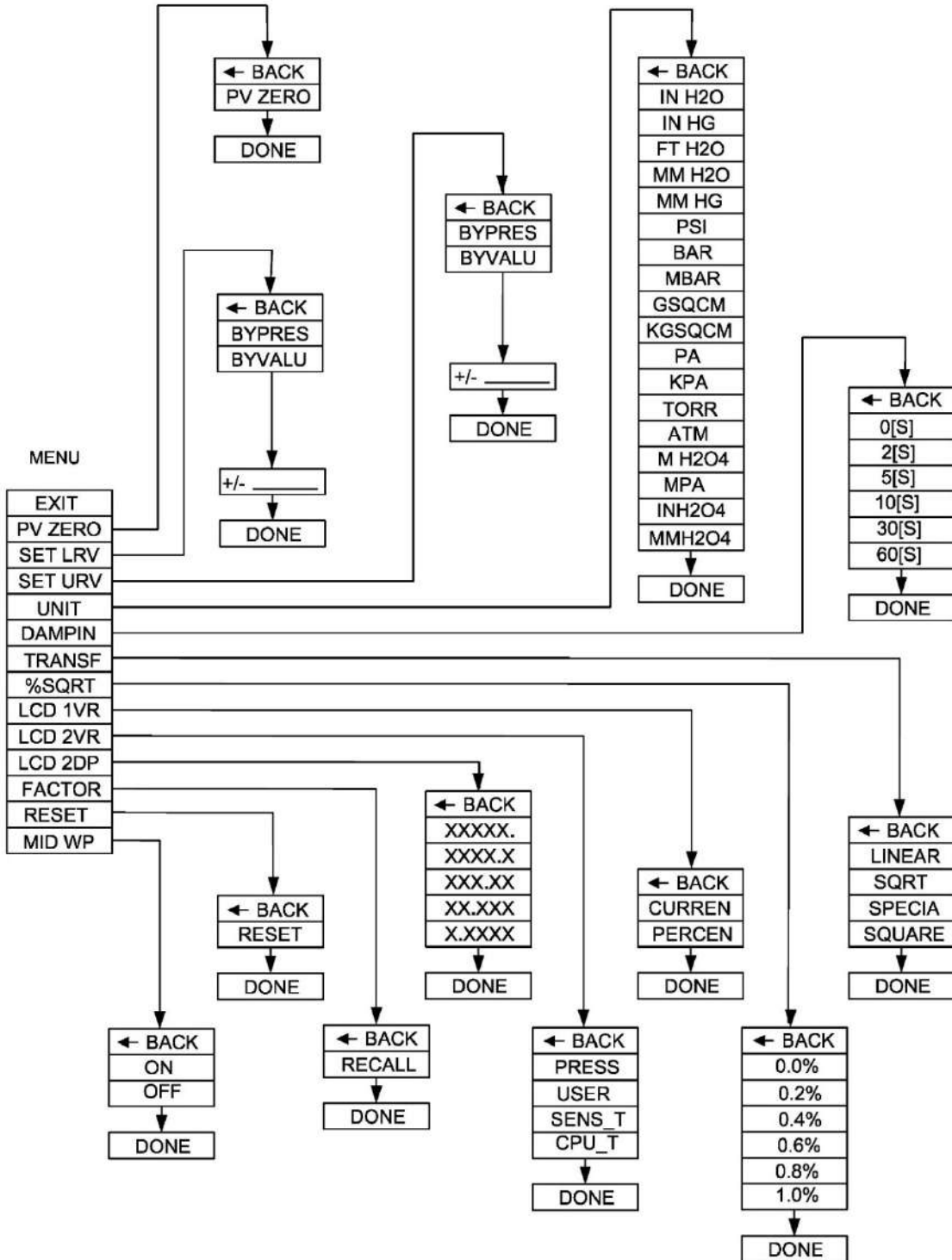


Figure 13. Local menu structure of transmitter

## 9.7. Remote configuration of setpoints (HART 5/HART 7)

The transmitter allows to read out and configure the parameters via HART communication using 4...20 mA loop as a physical layer for FSK BELL 202 modulation.

### 9.7.1. Compatible devices

The following devices may be used to communicate with the transmitter:

- Aplsens S.A. KAP-03, KAP-03Ex communicator (HART 5 only);
- communicators from other companies, including those using DDL and DTM libraries;
- PC computers equipped with HART modem (e.g. HART/USB converter by Aplsens S.A.) with Windows7 or Windows10 operating system with installed Raport 2;
- PC computers equipped with HART modem using software from other companies, accepting DDL and DTM libraries;
- smartphones with Android system, using a converter providing wireless communication (e.g. HART/USB converter by Aplsens S.A.) using Aplsens Mobile Configurator. The software is available on Google Play under the link:

<https://play.google.com/store/apps/details?id=com.aplisens.mobile.amc>.

### 9.7.2. Compatible configuration software

- Raport 2 Aplsens under control of Windows 7 or Windows 10;
- Aplsens Mobile Configurator under control of the Android system;
- every software from other companies accepting DDL and DTM libraries.

### 9.7.3. Local HART communication jumper

The transmitter allows to use the local HART communication. To do this you can use a HART communicator unit or modem interoperating with a computer or a smartphone.

In order to establish communication, it is necessary to:

- remove the HART communication jumper (→ [Figure 6. Electrical connection 4...20 mA of HART to transmitter in standard version](#));
- connect the communicator or modem to terminals (→ [Connection of transmitter with the option of using local HART communication](#)).

## 10. MAINTENANCE

### 10.1. Periodic inspections

Periodic inspections shall be carried out in accordance with applicable standards. During the inspection, the condition of the pressure (absence of loosened elements and leaks) and electrical (check of connections reliability and condition of gaskets and glands) connectors, condition of separating diaphragms (tarnish, corrosion) and stability of fixing of the housing and mounting bracket (if used) shall be checked. Check the processing characteristics by performing the operations specific for the CALIBRATION and possibly CONFIGURATION procedure.

### 10.2. Non-periodic inspections

If the transmitter at the installation site has been exposed to mechanical damage, pressure overload, hydraulic pulses, overvoltage, deposits, medium crystallization, undercutting of the diaphragm, or incorrect operation of the transmitter is detected, the device should be inspected. Check the condition of the diaphragm, clean it, check the electrical functionality of the transmitter and the processing characteristics.



If there is no signal in the transmission line or its value is improper, check the supply line, connection status on terminal blocks, connectors, etc. Check if the supply voltage and load resistance are correct.

### 10.3. Cleaning/washing

To remove impurities from the external surfaces of the transmitter wipe it with a cloth dampened in water.

### 10.4. Diaphragm cleaning

The only possible method of cleaning the transmitter diaphragms is to dissolve the sludge produced.



Do not remove deposits and impurities from the transmitter diaphragms, which are formed during operation, mechanically using tools, since the diaphragms and the transmitter can be damaged.

## 10.5. Spare parts

Parts of the transmitter that may be worn or damaged and thus replaced: cover seal.



**Other parts in the case of ATEX, PED type of transmitter may be replaced only by the manufacturer or an authorized representative.**

## 10.6. Repair

Faulty or non-operational transmitter shall be provided to the manufacturer.

## 10.7. Returns

In the following cases, the transmitter should be returned directly to the manufacturer:

- need for repair;
- need for factory calibration;
- replacement of improperly selected/shipped transmitter.

## 11. SCRAPPING, DISPOSAL



Worn or damaged devices shall be scrapped in accordance with WEEE Directive (2012/19/EU) on waste electrical and electronic equipment or returned to the manufacturer.

## 12. HISTORY OF REVISIONS

Revision No.	Document revision	Description of changes
-	01.A.001/2019.07	Initial document version. Prepared by DR, DKD, KBF, DCF.
1	01.A.002/2019.09	QR codes and ID numbers have been changed. Prepared by DR, DKD, KBF, DCF.
2	01.A.003/2019.10	Change of QR codes and ID numbers due to introduction of software with HART 7 stack. Prepared by DR, DKD, KBF, DCF.
3	01.A.004/2020.03	Added information about PED execution. Prepared by DBFD.
4	02.A.005/2020.06	New document edition. Prepared by DBFD.
5	02.A.006/2020.10	Supplemented the ID numbers. Prepared by DBFD.
6	02.A.007/2021.06	Added information about FM certificate for US and Canada, editorial changes.
7	02.B.001/2023.04	Editorial changes, change of QR codes and ID numbers due to the update of explosion proof certificates. Added UKCA transmitters. Prepared by DBFD.